

## DM74LS245 3-STATE Octal Bus Transceiver

### General Description

These octal bus transceivers are designed for asynchronous two-way communication between data buses. The control function implementation minimizes external timing requirements.

The device allows data transmission from the A Bus to the B Bus or from the B Bus to the A Bus depending upon the logic level at the direction control (DIR) input. The enable input ( $\bar{G}$ ) can be used to disable the device so that the buses are effectively isolated.

### Features

- Bi-Directional bus transceiver in a high-density 20-pin package
- 3-STATE outputs drive bus lines directly
- PNP inputs reduce DC loading on bus lines
- Hysteresis at bus inputs improve noise margins
- Typical propagation delay times, port-to-port 8 ns
- Typical enable/disable times 17 ns
- $I_{OL}$  (sink current)  
24 mA
- $I_{OH}$  (source current)  
-15 mA

### Ordering Code:

Order Number	Package Number	Package Description
DM74LS245WM	M20B	20-Lead Small Outline Integrated Circuit (SOIC), JEDEC MS-013, 0.300 Wide
DM74LS245SJ	M20D	20-Lead Small Outline Package (SOP), EIAJ TYPE II, 5.3mm Wide
DM74LS245N	N20A	20-Lead Plastic Dual-In-Line Package (PDIP), JEDEC MS-001, 0.300 Wide

Devices also available in Tape and Reel. Specify by appending the suffix letter "X" to the ordering code.

### Connection Diagram

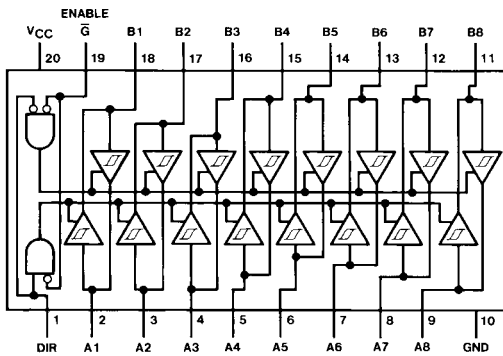

### Function Table

Enable $\bar{G}$	Direction Control DIR	Operation
L	L	B Data to A Bus
L	H	A Data to B Bus
H	X	Isolation

H = HIGH Level  
L = LOW Level  
X = Irrelevant

**Absolute Maximum Ratings**(Note 1)

Supply Voltage	7V
Input Voltage	
DIR or $\bar{G}$	7V
A or B	5.5V
Operating Free Air Temperature Range	0°C to +70°C
Storage Temperature Range	-65°C to +150°C

**Note 1:** The "Absolute Maximum Ratings" are those values beyond which the safety of the device cannot be guaranteed. The device should not be operated at these limits. The parametric values defined in the Electrical Characteristics tables are not guaranteed at the absolute maximum ratings. The "Recommended Operating Conditions" table will define the conditions for actual device operation.

**Recommended Operating Conditions**

Symbol	Parameter	Min	Nom	Max	Units
$V_{CC}$	Supply Voltage	4.75	5	5.25	V
$V_{IH}$	HIGH Level Input Voltage	2			V
$V_{IL}$	LOW Level Input Voltage			0.8	V
$I_{OH}$	HIGH Level Output Current			-15	mA
$I_{OL}$	LOW Level Output Current			24	mA
$T_A$	Free Air Operating Temperature	0		70	°C

**Electrical Characteristics**

over recommended operating free air temperature range (unless otherwise noted)

Symbol	Parameter	Conditions	Min	Typ (Note 2)	Max	Units
$V_I$	Input Clamp Voltage	$V_{CC} = \text{Min}$ , $I_I = -18 \text{ mA}$			-1.5	V
HYS	Hysteresis ( $V_{T+} - V_{T-}$ )	$V_{CC} = \text{Min}$	0.2	0.4		V
$V_{OH}$	HIGH Level Output Voltage	$V_{CC} = \text{Min}$ , $V_{IH} = \text{Min}$ $V_{IL} = \text{Max}$ , $I_{OH} = -1 \text{ mA}$	2.7			V
		$V_{CC} = \text{Min}$ , $V_{IL} = \text{Min}$ $V_{IL} = \text{Max}$ , $I_{OH} = -3 \text{ mA}$	2.4	3.4		
		$V_{CC} = \text{Min}$ , $V_{IH} = \text{Min}$ $V_{IL} = 0.5 \text{ V}$ , $I_{OH} = \text{Max}$	2			
$V_{OL}$	LOW Level Output Voltage	$V_{CC} = \text{Min}$ $V_{IL} = \text{Max}$ $V_{IH} = \text{Min}$	$I_{OL} = 12 \text{ mA}$ $I_{OL} = \text{Max}$		0.4 0.5	V
$I_{OZH}$	Off-State Output Current, HIGH Level Voltage Applied	$V_{CC} = \text{Max}$ $V_{IL} = \text{Max}$	$V_O = 2.7 \text{ V}$		20	$\mu\text{A}$
$I_{OZL}$	Off-State Output Current, LOW Level Voltage Applied	$V_{IH} = \text{Min}$	$V_O = 0.4 \text{ V}$		-200	$\mu\text{A}$
$I_I$	Input Current at Maximum Input Voltage	$V_{CC} = \text{Max}$	A or B $V_I = 5.5 \text{ V}$		0.1	mA
			DIR or $\bar{G}$ $V_I = 7 \text{ V}$		0.1	
$I_{IH}$	HIGH Level Input Current	$V_{CC} = \text{Max}$ , $V_I = 2.7 \text{ V}$			20	$\mu\text{A}$
$I_{IL}$	LOW Level Input Current	$V_{CC} = \text{Max}$ , $V_I = 0.4 \text{ V}$			-0.2	mA
$I_{OS}$	Short Circuit Output Current	$V_{CC} = \text{Max}$ (Note 3)			-40 -225	mA
$I_{CC}$	Supply Current	$V_{CC} = \text{Max}$	Outputs HIGH		48 70	mA
			Outputs LOW		62 90	
			Outputs at Hi-Z		64 95	

**Note 2:** All typicals are at  $V_{CC} = 5 \text{ V}$ ,  $T_A = 25^\circ\text{C}$ .

**Note 3:** Not more than one output should be shorted at a time, not to exceed one second duration

<b>Switching Characteristics</b>					
$V_{CC} = 5V, T_A = 25^\circ C$					
Symbol	Parameter	Conditions	Min	Max	Units
$t_{PLH}$	Propagation Delay Time, LOW-to-HIGH Level Output	$C_L = 45\text{ pF}$ $R_L = 667\Omega$		12	ns
$t_{PHL}$	Propagation Delay Time, HIGH-to-LOW Level Output			12	ns
$t_{PZL}$	Output Enable Time to LOW Level			40	ns
$t_{PZH}$	Output Enable Time to HIGH Level			40	ns
$t_{PLZ}$	Output Disable Time from LOW Level	$C_L = 5\text{ pF}$ $R_L = 667\Omega$		25	ns
$t_{PHZ}$	Output Disable Time from HIGH Level			25	ns
$t_{PLH}$	Propagation Delay Time, LOW-to-HIGH Level Output	$C_L = 150\text{ pF}$ $R_L = 667\Omega$		16	ns
$t_{PHL}$	Propagation Delay Time, HIGH-to-LOW Level Output			17	ns
$t_{PZL}$	Output Enable Time to LOW Level			45	ns
$t_{PZH}$	Output Enable Time to HIGH Level			45	ns

**Physical Dimensions** inches (millimeters) unless otherwise noted

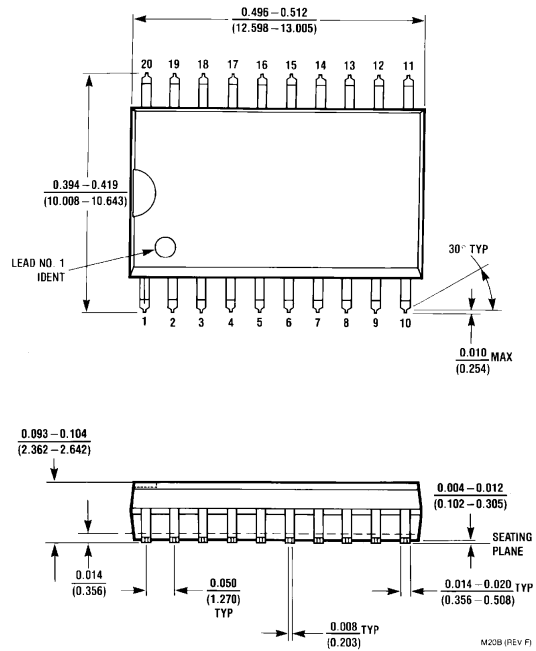

**20-Lead Small Outline Integrated Circuit (SOIC), JEDEC MS-013, 0.300 Wide  
Package Number M20B**

**Physical Dimensions** inches (millimeters) unless otherwise noted (Continued)

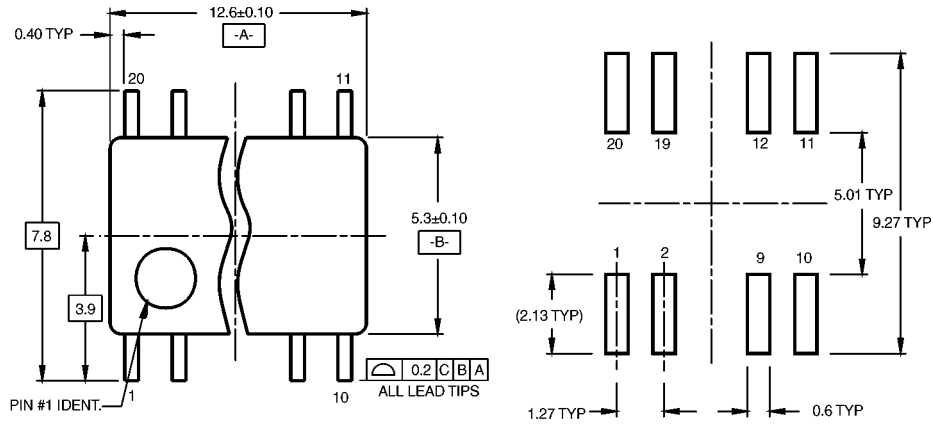

**LAND PATTERN RECOMMENDATION**

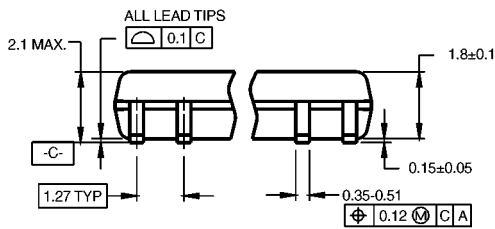

DIMENSIONS ARE IN MILLIMETERS

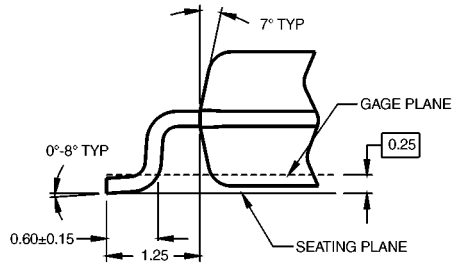
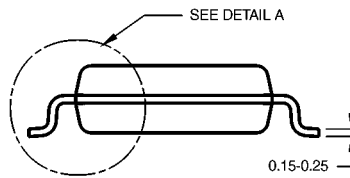

**DETAIL A**

- NOTES:
- A. CONFORMS TO EIAJ EDR-7320 REGISTRATION, ESTABLISHED IN DECEMBER, 1998.
  - B. DIMENSIONS ARE IN MILLIMETERS.
  - C. DIMENSIONS ARE EXCLUSIVE OF BURRS, MOLD FLASH, AND TIE BAR EXTRUSIONS.

M20DRevB1

**20-Lead Small Outline Package (SOP), EIAJ TYPE II, 5.3mm Wide  
Package Number M20D**

**Physical Dimensions** inches (millimeters) unless otherwise noted (Continued)

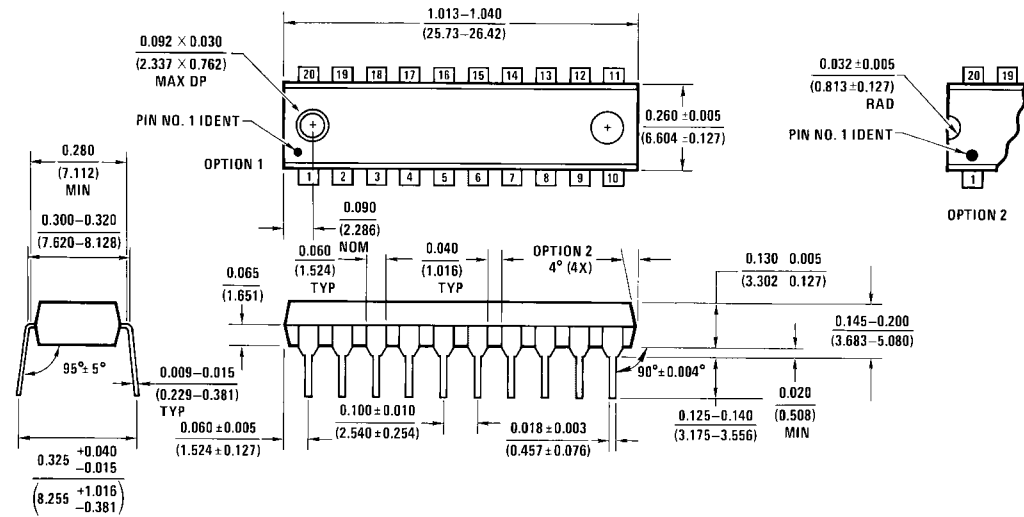

**20-Lead Plastic Dual-In-Line Package (PDIP), JEDEC MS-001, 0.300 Wide  
Package Number N20A**

N20A (REV G)

Fairchild does not assume any responsibility for use of any circuitry described, no circuit patent licenses are implied and Fairchild reserves the right at any time without notice to change said circuitry and specifications.

**LIFE SUPPORT POLICY**

FAIRCHILD'S PRODUCTS ARE NOT AUTHORIZED FOR USE AS CRITICAL COMPONENTS IN LIFE SUPPORT DEVICES OR SYSTEMS WITHOUT THE EXPRESS WRITTEN APPROVAL OF THE PRESIDENT OF FAIRCHILD SEMICONDUCTOR CORPORATION. As used herein:

1. Life support devices or systems are devices or systems which, (a) are intended for surgical implant into the body, or (b) support or sustain life, and (c) whose failure to perform when properly used in accordance with instructions for use provided in the labeling, can be reasonably expected to result in a significant injury to the user.
2. A critical component in any component of a life support device or system whose failure to perform can be reasonably expected to cause the failure of the life support device or system, or to affect its safety or effectiveness.

[www.fairchildsemi.com](http://www.fairchildsemi.com)